

E1B-4LRV(3.6)

4MP Dual-light Bullet Camera



Features

- Supports backlight adaptation and overcast adaptation
- 1/3" CMOS sensor
- 120 dB super wide dynamic range (WDR), ensuring that both foreground and background objects are clearly identified in environments with sharp light contrast
- H.265 or H.264 HD encoding at a low bit rate
- 50 m IR range and 30 m white light range
- Built-in speaker and microphone for voice interaction
- Supports human shape detection
- Support SuperCoding
- Support Intelligent recording marking

Model		E1B-4LRV(3.6)				
Major Specifications						
Main control	Memory	DDR3 128.0 MB				
	Flash type	SPI NAND FLASH 128.0 MB				
Camera	Focal length	3.6mm				
	Max Aperture	F1.6				
	Image sensor	1/3"/4MP 2560(H)*1440(V)				
	Lens Aperture type	Fixed iris				
	Angle of view	Horizontal: 78° ; vertical: 42°				
	IR range	50m				
	Illumination range	30m				
	IR Wavelength	850nm				
	DORI(Complied with the EN 62676-4)		D(m)	O(m)	R(m)	I(m)
		W	72.0	29.0	14.4	7.2

Intelligence		
Intelligent identification	Intelligent recording marking	Link with HWT-IVS1800 and intelligently mark video content (pedestrians, vehicles & bicycles) with different colors, so as to facilitate video search.
Event detection	Event detection	Motion detection, human figure detection and lens blocking detection
Other intelligences	Behavior analysis	Tripwire crossing/Intrusion/Area entry or exit/Fast-Moving monitoring

Image		
Codec	Video encoding format	H.264/H.265/SuperCoding
	Video encoding channels	Dual streams
	Video frame rate	25 fps/30 fps (configurable)
Image AI	Scene adaptation	Overcast adaptation
Image ISP	Min illumination	Color: 0.02 lux (F1.2, AGC ON, 1/30s shutter speed); B/W: 0.01 lux (F1.2, AGC ON, 1/30s shutter speed) or 0 lux (infrared illuminator enabled)
	Day/Night mode	Day/Night mode: automatic, color, B/W, and scheduled (default: automatic) Sensitivity: 1-10 (default: 5) Nighttime start time: 18:00:00 by default Daytime start time: 06:00:00 by default Filtering time: 2s to 120s (default: 5s)
	WDR	120db
	White balance	Auto/Manual/Automatic tracking/Global/Locked
	HLC/BLC	Supported/supported
	Shutter speed	Shutter speed range: 1/100000s to 1/3s Default value in live video mode: 1/25s
	SNR	>45dB
	Primary stream resolution	2560×1440(4MP),1920×1080(1080P),1280×720(720P),720×576(D1)
	Secondary stream resolution	Secondary stream 1:720×576(D1_PAL),720×480(D1_NTSC),352×288(CIF_PAL),352×240(CIF_NTSC)
	Video bit rate	4MP:512kbit/s to 8Mbit/s; 3MP: 512kbit/s to 8Mbit/s; 1080P:256kbit/s to 8Mbit/s; 720P:256kbit/s to 4Mbit/s; D1:256K to 2Mbit/s; CIF:32K to 1Mbit/s;
Digital noise reduction	2D/3D noise reduction	

Open ecosystem		
Data openness	Data openness	SDK (proprietary protocol)/REST API (proprietary protocol)/ONVIF Profile S/G/T

Audio		
Audio	Audio encoding format	G.711a/G.711u/G.726/AAC (default: G.711a)
	Audio sampling rate	G.711a/G.711u/G.726:8K AAC:8K/16K/22.05K/24K/32K/44.1K/48K
	Audio bit rate	G.711a/G.711u: 64 kbit/s G.726: configurable (16/24/32/40 kbit/s) AAC: 8 kHz sampling rate: 16/22/24/32/48 kbit/s 16 kHz sampling rate: 24/32/48/64/96 kbit/s 22.05/24/32 kHz sampling rate: 32/48/64/96/128 kbit/s 44.1/48 kHz sampling rate: 48/64/96/128/256 kbit/s

Networking		
Network transmission	Protocols supported by IPv4	TCP, UDP, IPv4, DHCP, DNS, ICMP, IGMP, HTTPS, FTP, SFTP, RTP, RTSP, RTCP, SIP, ARP, SSL, NTP, QoS,SMTP
	Protocols supported by IPv6	HTTPS,RTP,RTCP,RTSP,Onvif,IPv6,ICMPv6,DHCPv6
Web Browser	Web Browser	Google Chrome, Firefox, Edge

Security		
Service security	User rights	Three user roles: administrator, advanced operator, and common operator
	Security mode	User name and password authentication, 802.1X authentication, and HTTPS digital certificate
	Secure boot	Supported
Alarm information	Alarm information	HTTPS certificate expiration/SDK certificate expiration/SDK root certificate expiration/SDK revocation certificate expiration/Log certificate expiration/Network disconnection/Failure to write data to disks/Media stream interrupted/Flash read/write/Version rollback

General Specifications	
Power type	DC12V,PoE(IEEE 802.3af)
Power consumption	Maximum:6.6W,typical:1.9W
Operating temperature	-30°C to 60°C
Storage temperature	-40°C to 70°C
Operating humidity	5% to 95%(non-condensing)
Surge protection	4kV
IP rating	IP67
Equipment Anti Corrosion	Class C
Weight	Net weight 495g;Gross weight 632g
Dimensions	Device dimensions 259.5*109.5*105mm;Package dimensions 252*121*113mm
Language	Simplified Chinese, English, French, Spanish, Portuguese (Europe), Portuguese (Brazil), Thai, and Turkish

Port	
Storage port	One microSD card slot that supports microSDHC/microSDXC (maximum memory card capacity: 256 GB)
Network port	One RJ45 10M/100M adaptive Ethernet port
Audio port	Supported (one-channel built-in microphone)

Dimensions

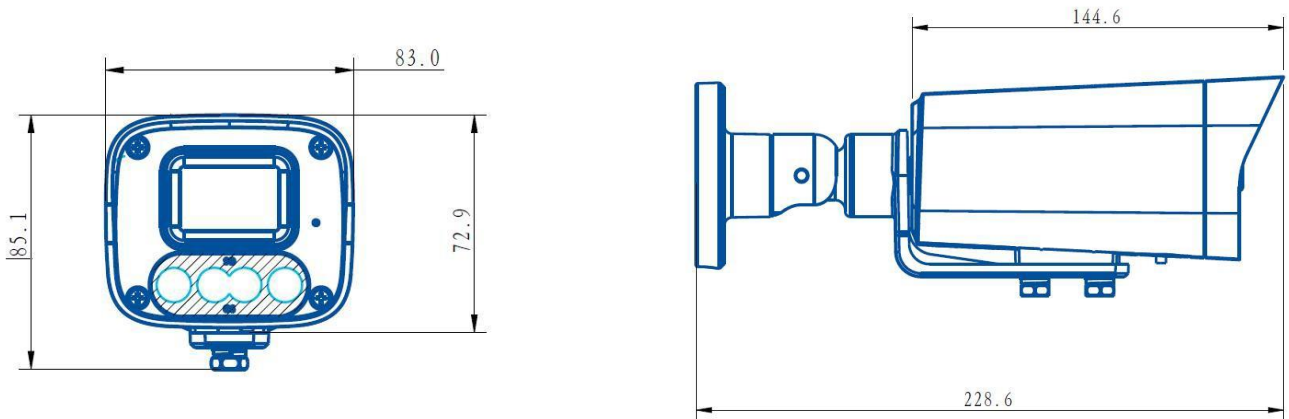

Recommended Accessories



ACC3233